

Caution: Protect floor when using transport casters.

Contact Area of Oven Stand	801	in ²
	5.56	ft ²
Oven Weight	5,700	lb
PSF Floor Loading of Oven Stand	1,025	lb/ft ²
PSI Floor Loading of Oven Stand	7.1	lb/in ²

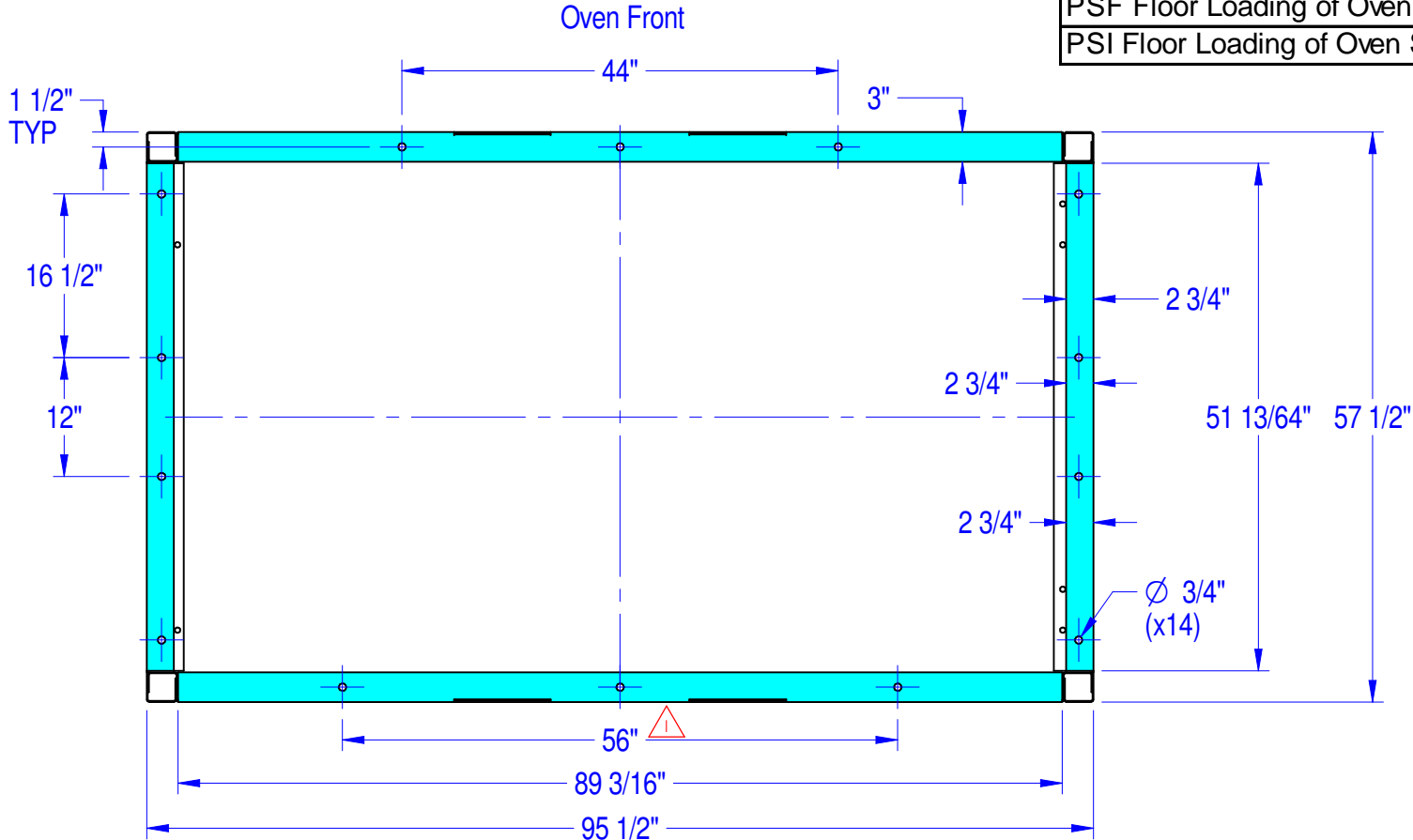

Oven's Contact Area with Floor

DIMENSIONS ARE IN INCHES
 LINEAR TOLERANCES ±1/4"
 UNLESS NOTED OTHERWISE

THE INFORMATION CONTAINED IN THIS DRAWING IS THE SOLE PROPERTY OF WOOD STONE CORPORATION
 ANY REPRODUCTION OR USE IN PART OR AS A WHOLE WITHOUT THE WRITTEN PERMISSION OF WOOD STONE IS PROHIBITED

SHEET: 1 of 1	REV: 1
DWN BY: charleyh	
PART #: 001-509660-1-FP	
DATE: 9/8/2016	

Wood Stone

Bellingham, WA 98226 (360) 650-1111 www.woodstone-corp.com

Fire Deck Stone Hearth Oven
Fire Deck 9660 (WS-FD-9660) Foot Print